

# HBS57 3-phase Hybrid Servo Drive

## 20-50V, 8.0A Peak, No Tuning, Nulls loss of Synchronization

- n Closed-loop, eliminates loss of synchronization
- n Broader operating range – higher torque and higher speed
- n Reduced motor heating and more efficient
- n Smooth motion and super-low motor noise
- n Do not need a high torque margin
- n No Tuning and always stable
- n Fast response, no delay and almost no settle time
- n High torque at starting and low speed, high stiffness at standstill
- n Lower cost



### Descriptions

The HBS series offers an alternative for applications requiring high performance and high reliability when the servo was the only choice, while it remains cost-effective. The system includes a 3-phase stepper motor combined with a fully digital, high performance drive and an internal encoder which is used to close the position, velocity and current loops in real time, just like servo systems. It combines the best of servo and stepper motor technologies, and delivers unique capabilities and enhancements over both, while at a fraction of the cost of a servo system.

### Applications

The HBS series offers an alternative for applications requiring high performance and high reliability when the servo was the only choice, while it remains cost-effective. Its great feature of fast response and no hunting make it ideal for applications such as bonding and vision systems in which rapid motions with a short distance are required and hunting would be a problem. And it is ideal for applications where the equipment uses a belt-drive mechanism or otherwise has low rigidity and you don't want it to vibrate when stopping.

## Specifications

### Electrical Specifications

Parameter	Min	Typical	Max	Unit
Input Voltage	20	36	50	VDC
Output Current	0	-	8.0(Peak)	A
Pulse Input Frequency	0	-	200	kHz
Logic Signal Current	7	10	16	mA
Isolation Resistance	500	-	-	MΩ

### Operating Environment

<b>Cooling</b>	Natural Cooling or Forced cooling	
<b>Operating Environment</b>	Environment	Avoid dust, oil fog and corrosive gases
	Storage Temperature	-20°C — 65°C (-4°F — 149°F)
	Ambient Temperature	0°C — 50°C (32°F — 122°F)
	Humidity	40%RH — 90%RH
	Operating Temperature (Heat Sink)	70°C (158°F) Max
<b>Storage Temperature</b>	-20°C — 65°C (-4°F — 149°F)	
<b>Weight</b>	280 g (9.8)	

## Mechanical Specifications

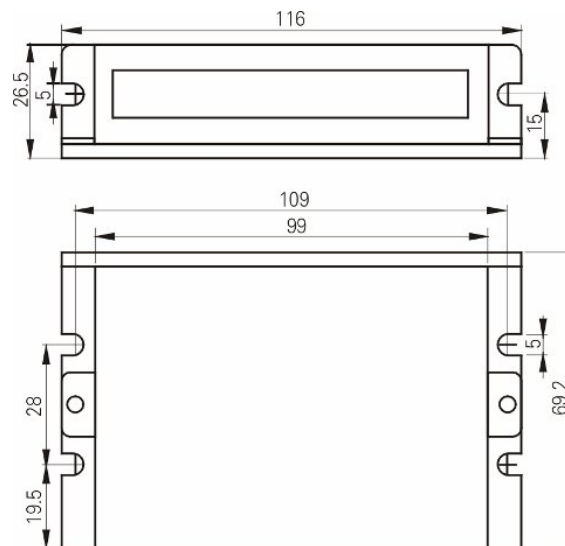

## Protection Indications

The green indicator turns on when power-up. When drive protection is activated, the red LED blinks periodically to indicate the error type.

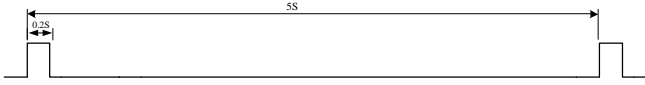
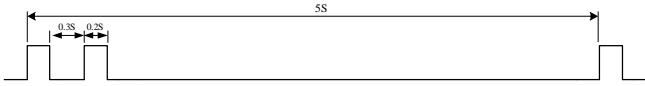
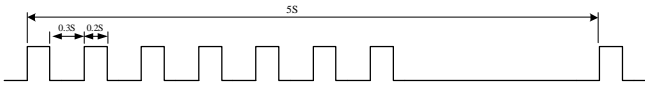
Priority	Time(s) of Blink	Sequence wave of RED LED	Description
1st	1		Over-current protection
2nd	2		Over-voltage protection
3rd	7		Position Following Error

## Connectors and Pin Assignment

The HBS57 has three connectors, connector for control signals connections, connector for encoder feedback and connector for power and motor connections.

Control Signal Connector - Screw Terminal			
Pin	Name	I/O	Description
1	PUL+	I	<u>Pulse signal</u> : In single pulse (pulse/direction) mode, this input represents pulse signal, each rising or falling edge active (software configurable, see hybrid servo software operational manual for more detail); In double pulse mode (software configurable), this input represents clockwise (CW) pulse, active both at high level and low level. 4-5V when PUL-HIGH, 0-0.5V when PUL-LOW. For reliable response, pulse width should be longer than 10μs. Series connect resistors for current-limiting when +12V or +24V used. The same as DIR and ENA signal.
2	PUL-	I	
3	DIR+	I	<u>Direction Signal</u> : In single-pulse mode, this signal has low/high voltage levels, representing two directions of motor rotation. In double-pulse mode (software configurable), this signal is counter-clock (CCW) pulse, active both at high level and low level. For reliable motion response, DIR signal should be ahead of PUL signal by 5μs at least. 4-5V when DIR-HIGH, 0-0.5V when DIR-LOW. Please note that rotation direction is also related to motor-driver wiring match. Exchanging the connection of two wires for a coil to the driver will reverse motion direction. The direction signal's polarity is software configurable.
4	DIR-	I	
5	ENA+	I	<u>Enable signal</u> : This signal is used for enabling/disabling the driver. In default, high level (NPN control signal) for enabling the driver and low level for disabling the driver. Usually left <b>UNCONNECTED (ENABLED)</b> . Please note that PNP and Differential control signals are on the contrary, namely Low level for enabling. The active level of ENA signal is software configurable.
6	ENA-	I	
7	ALM+	O	<u>Alarm Signal</u> : OC output signal, active when one of the following protection is activated: over-voltage, over current, short circuit and position following error. This port can sink or source 20mA current at 24V. In default, the resistance between ALM+ and ALM- is low impedance in normal operation and become high when HBS57 goes into error. The active level of alarm signal is software configurable. See Hybrid servo software operational manual for more detail.
8	ALM-	O	

Encoder Feedback Connector – HDD15 Female			
Pin	Name	I/O	Description
1	EA+	I	Encoder channel A+ input
2	EB+	I	Encoder channel B+ input
3	EGD	GND	Signal ground
4	HW	I	Reserved
5	HU	I	Reserved
6	FG	-	Ground terminal for shielded
7	EZ+	I	Reserved
8	EZ-	I	Reserved
9	HV	I	Reserved
10	NC	-	Not Connected
11	EA-	I	Encoder channel A- input
12	EB-	I	Encoder channel B- input
13	VCC	O	+5V @ 100 mA max.
14	NC	-	Not Connected
15	NC	-	Not Connected

Power and Motor Connector- Screw Terminal			
Pin	Name	I/O	Description
1	U	O	Motor Phase U
2	V	O	Motor Phase V
3	W	O	Motor Phase W
4	+Vdc	I	Power Supply Input (Positive) 20-45VDC recommended, leaving rooms for voltage fluctuation and back-EMF.
5	GND	GND	Power Ground (Negative)

## RS232 Communication Port

It is used to configure the peak current, microstep, active level, current loop parameters and anti-resonance parameters. See EM driver's software operational manual for more information.

RS232 Communication Port – RJ11			
Pin	Name	I/O	Description
1	NC	-	Not connected.
2	+5V	O	+5V power only for STU (Simple Tuning Unit).
3	TxD	O	RS232 transmit.
4	GND	GND	Ground.
5	RxD	I	RS232 receive.
6	NC	-	Not connected.

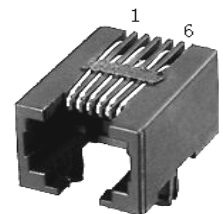

## DIP Switch - Motor SEL

It is reserved for future use. Now there is no function for these DIP switch.

## Current Control

The motor current will be adjusted automatically regarding to the load or the stator-rotor relationship. However, the user can also configure the current in the tuning software. The configurable parameters include close-loop current, holding current, encoder resolution, micro step and etc. There are also PID parameters for the motor but they have been tuned according to Leadshine matching motor so the user does not need to tune them.

## Matching Motor Specifications

HBS57 can work with the following Leadshine three phase hybrid stepper motors with encoder as follows:

	573S09-EC-1000	573S20-EC-1000
Step Angle (Degree)	1.2	1.2
Holding Torque (N.m)	0.9	2.0
Phase Current (A)	5.8	5.8
Phase Resistance (Ohm)	0.35	0.62
Phase Inductance (mH)	0.72	1.85
Inertia (g.cm <sup>2</sup> )	280	580
Weight (Kg)	0.75	1.3
Encoder (lines / Rev.)	1000	1000

### Wiring Diagram

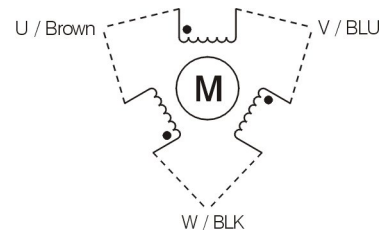

### 573S09-EC-1000 Mechanical Specification

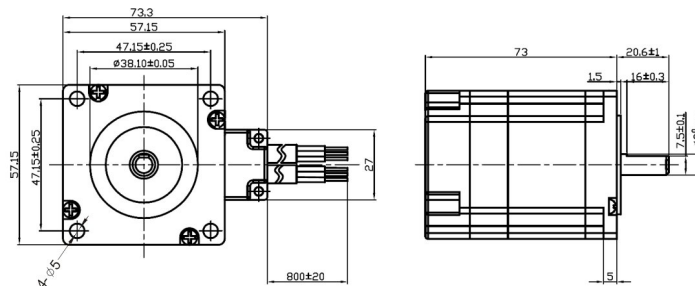

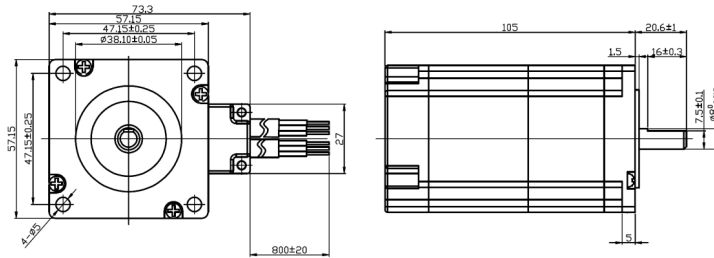
**573S20-EC-1000 Mechanical Specification**

**Typical Connections**
